

# DIY

INSTRUCTION MANUAL  
说明书

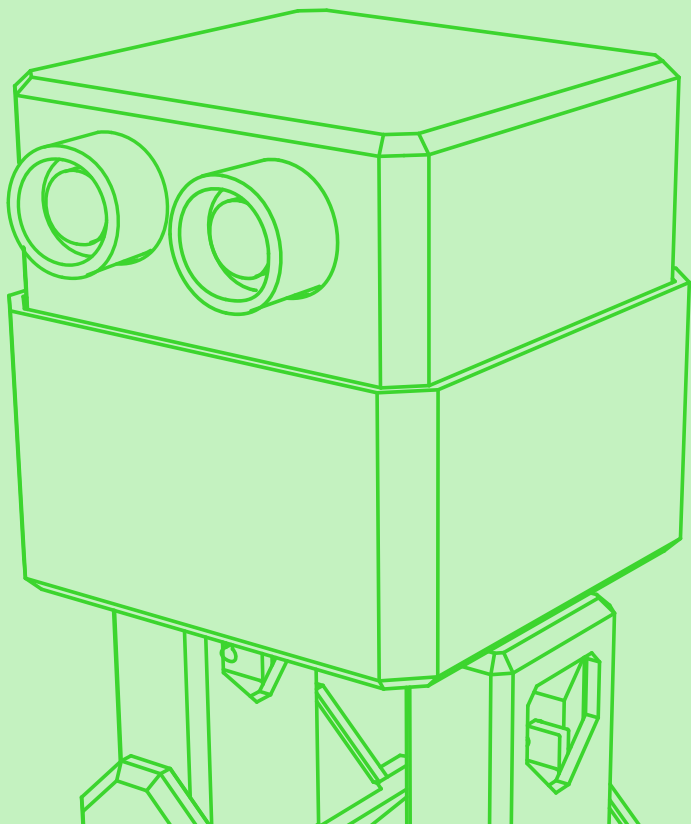

# build your own robot

## 打造你自己的机器人



### Otto is an interactive robot that anyone can make!

you will be able to build your own Otto in as little as two hours!  
easy to build and disassemble with a simple screwdriver.

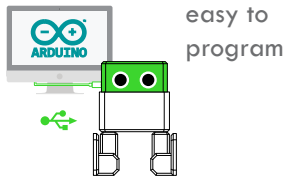
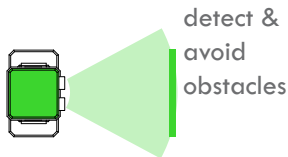
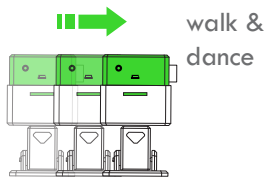

#OttoDIY

follow us!

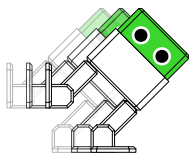

# PARTS

## 部分

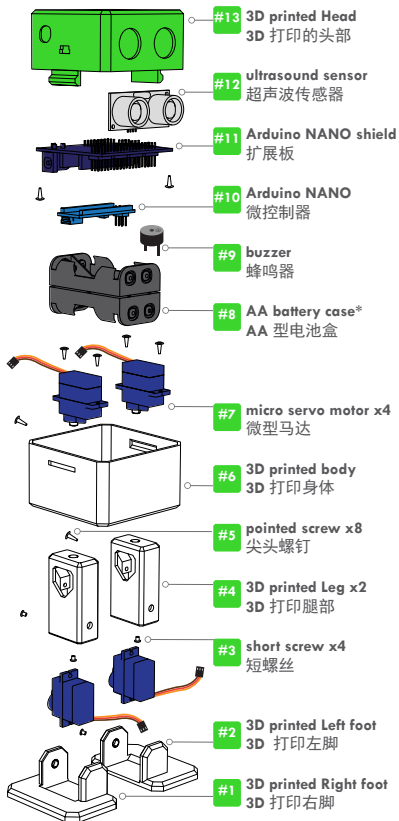

\*AA batteries not included

# 1



a

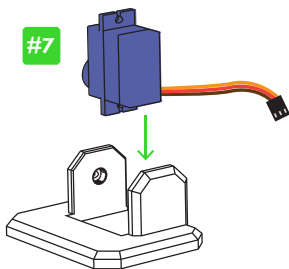

b

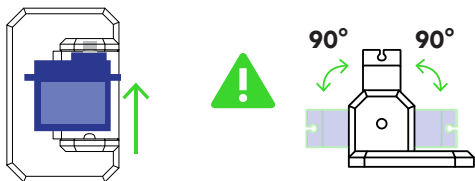

c

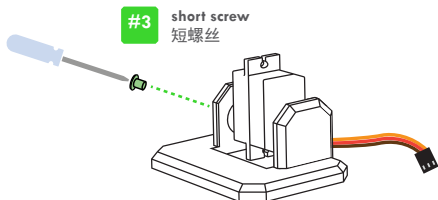

# 2



a

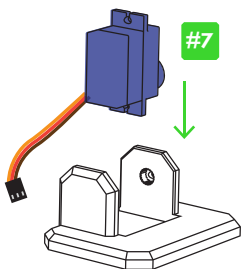

b

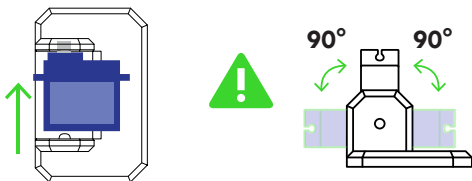

c

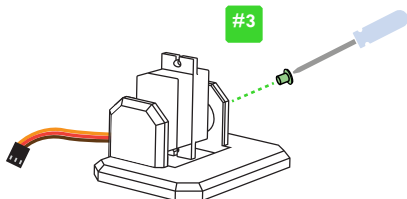

# 3



a

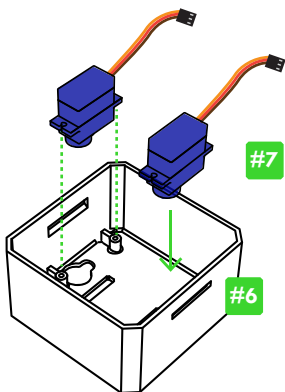

b

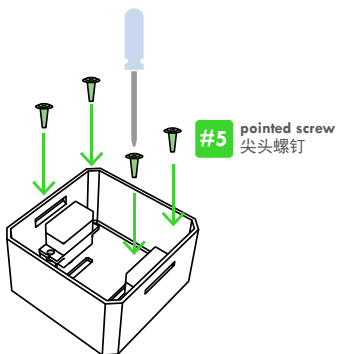

# 4



a

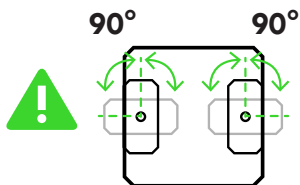
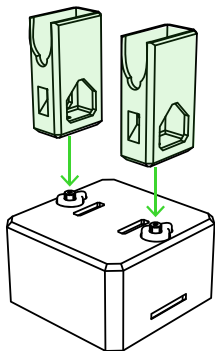

b

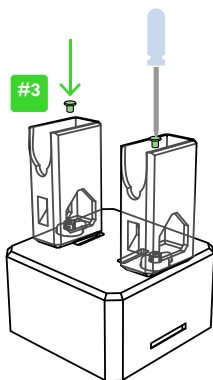

# 5



a

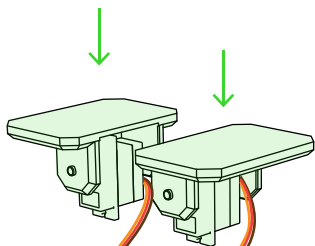

b

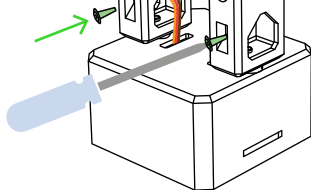



# 6



a

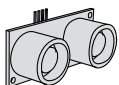

#12

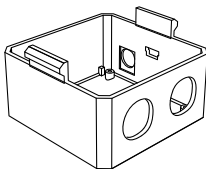

b

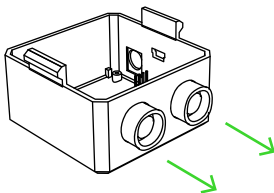

# 7



a

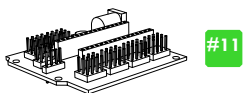
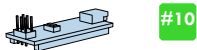

b

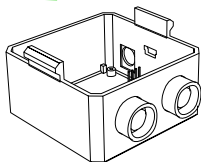
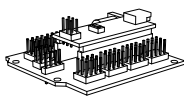

a

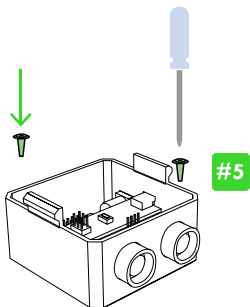

b

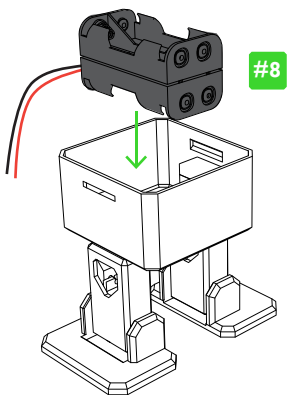

# 9



#9

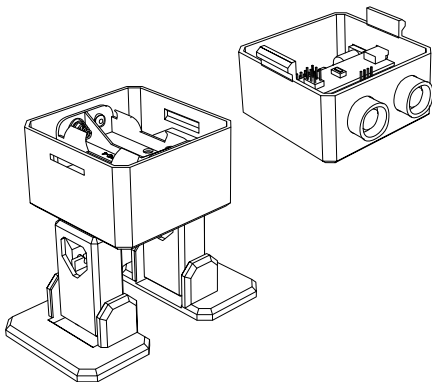

\*cable colors may vary

# 10

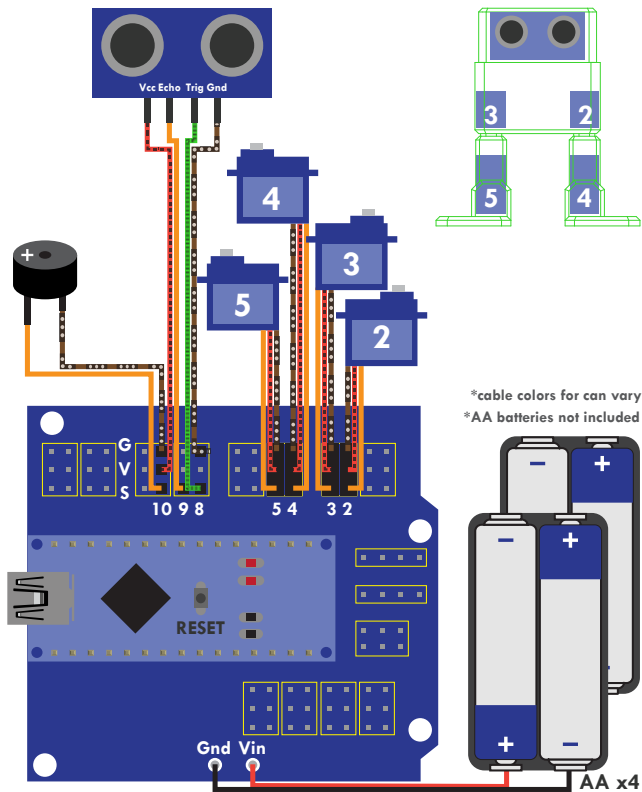

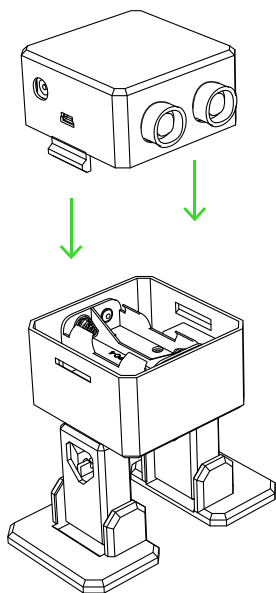

# 12

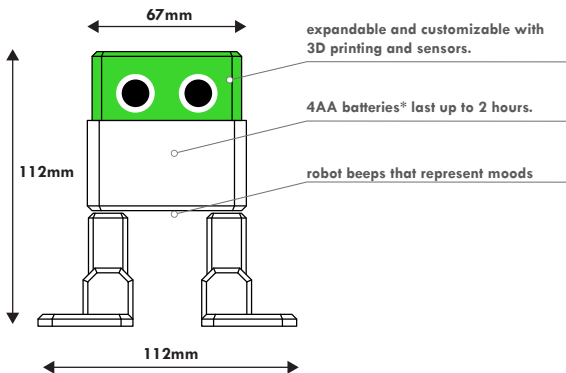
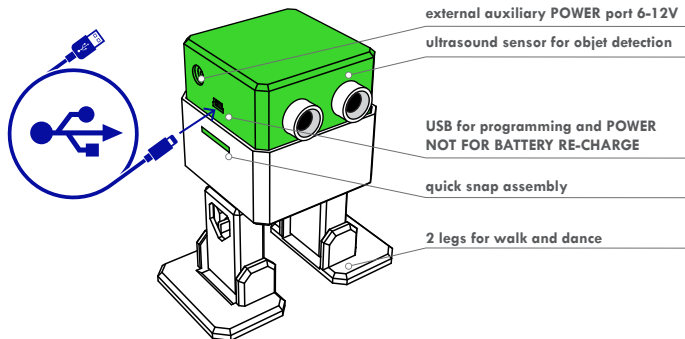

# DIY

## ARDUINO PROGRAMMING 编程

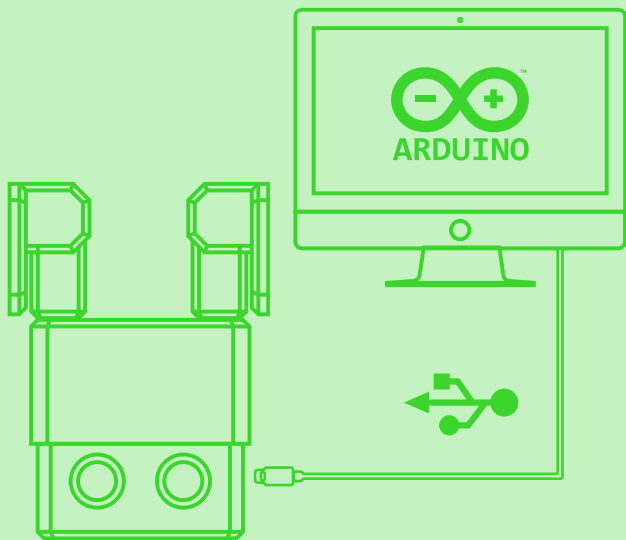



# 1



a

download Arduino for FREE to your computer from [www.arduino.cc](http://www.arduino.cc)



choose the appropriate Operating System installation package for your computer.



b

install Arduino in your computer...

# 2



- a** go to [ottodiy.com](http://ottodiy.com) in the build it! section download and unzip [OTTO\\_DIY\\_all.zip](#)
  
- b** from the “driver” folder install [CH341SER](#)
  -  choose the appropriate Operating System installation package for your computer.
  
- c** copy or move all “[libraries](#)” folders to:  
  
C:\Documents\Arduino\libraries\  
(or wherever your Arduino library folder is)
  
- d** copy or move all “[OTTO\\_](#)” folders to:  
  
C:\Documents\Arduino\  
(or wherever your Arduino sketch folder is)

# 3



- a** open Arduino and  
open OTTO\_avoid.ino



- b** Connect Otto to your computer USB

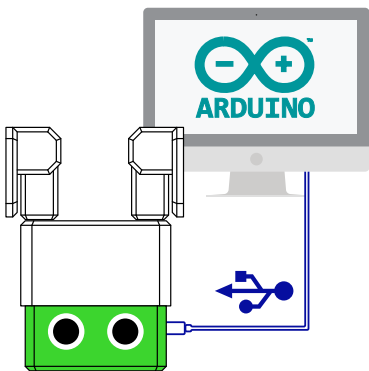

# 4



select in Arduino Tools/

- Board: "Arduino Nano"
- Processor: "ATmega328"
- Port COM# (where your Otto is connected)

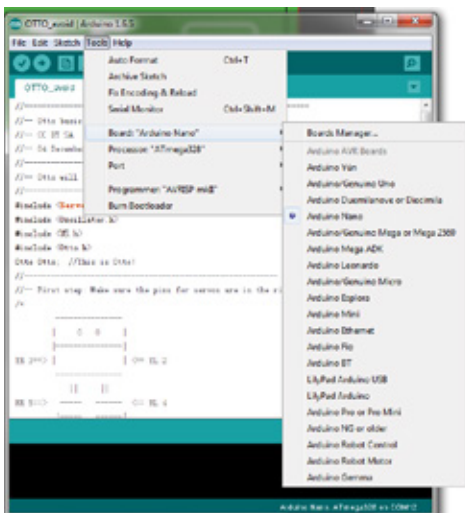

# 5



**a** verify the code 

**b** upload the code 

**c** Otto will walk endless until detect obstacles to avoid

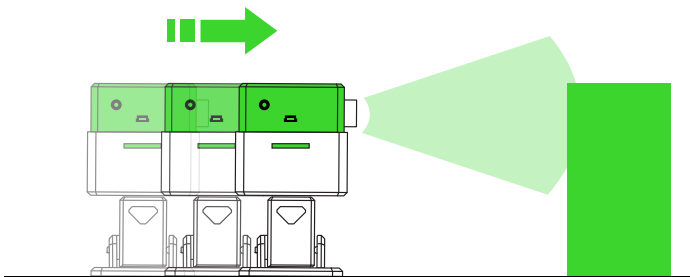

# 6



*in Arduino the principal loop code looks like this:*

```
OTTO_avoid.ino
```

```
52|void loop() {  
    if(obstacleDetected){  
        Otto.sing(S_surprise);  
        Otto.playGesture(OttoFretful);  
        Otto.sing(S_fart3);  
        Otto.walk(2,1300,-1);  
        Otto.turn(2,1000,-1);  
        delay(50);  
        obstacleDetector();  
    }  
    else{  
        Otto.walk(1,1000,1);  
        obstacleDetector();  
    }  
}
```

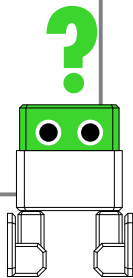





*play Gesture function:*

```
Otto.playGesture(OttoFretful);
```

play Gesture function

("emotion to express")

*try change emotion:*

(OttoSuperHappy);



(OttoSad);



(OttoSleeping);



(OttoFart);



(OttoConfused);



(OttoFretful);



(OttoLove);



(OttoAngry);



(OttoMagic);



(OttoWave);



(OttoVictory);



(OttoFail);





# 9



## *move functions:*

```
Otto.walk(2,1300,-1);
```



move function ("#steps, Time[ms], direction")

## *try change move function to:*

```
Otto.walk(1,1000,1);
```

```
Otto.walk(1,1000,-1);
```

```
Otto.turn(3,1000,1);
```

```
Otto.turn(3,1000,-1);
```

```
Otto.bend(2,1000,1);
```

```
Otto.bend(2,500,-1);
```

```
Otto.shakeLeg(1,1000,1);
```

```
Otto.shakeLeg(1,500,-1);
```

```
Otto.moonwalker(1,1000,moveSize,1);
```

*moveSize: "height of the move"*

```
Otto.moonwalker(1,1000,30,1);
```

```
Otto.crusaito(1,1000,moveSize,1);
```

```
Otto.flapping(1,1000,moveSize,1);
```

```
Otto.swing(1,1000,moveSize);
```

```
Otto.updown(1,1000,moveSize);
```

```
Otto.tiptoeSwing(1,1000,moveSize);
```

```
Otto.jitter(1,1000,moveSize);
```

```
Otto.ascendingTurn(1,1000,moveSize);
```

```
Otto.jump(1,1000);
```

# 10



post your creations online



#OttoDIY share!

expand...

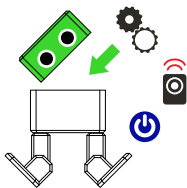

customize

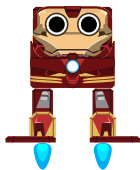

modify

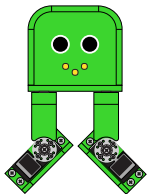

remix

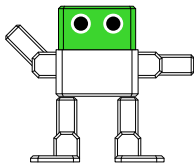



build your own robot  
打造你自己的机器人

[ottodiy.com](http://ottodiy.com)